

# FNR3012series

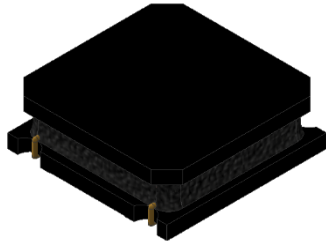

## CONSTRUCTION

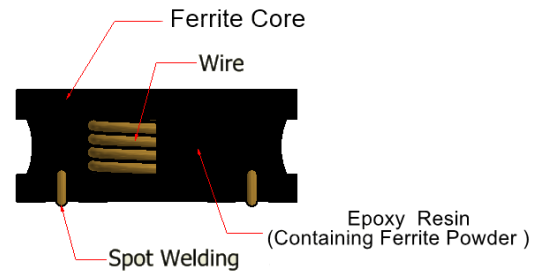

## FEATURES

Magnetically structure  
Low DC resistance  
Large Current Capability

## APPLICATIONS

Hard Disk Drives  
Car audio equipment  
Tablet PC  
Navigation system  
SSD  
Touch Panel

## SPECIFICATIONS

Operating temperature range	-40 to +125°C
Storage temperature range	Under 25°C
Packaging style	Taping
Quantities	2,000 pieces/reel

## SHAPE AND DIMENSIONS

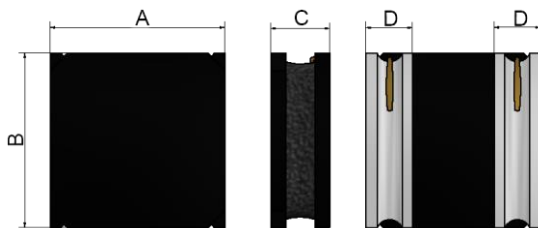

## RECOMMENDED PATTERN

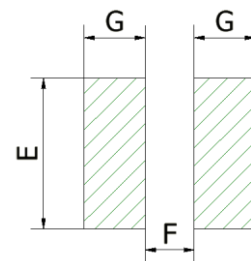

(Unit: mm)

TYPE	A	B	C	D	E	F	G
FNR3012	3.0±0.1	3.0±0.1	1.2max	0.9±0.2	3.2	1	1.1

## PRODUCT IDENTIFICATION (ex.)

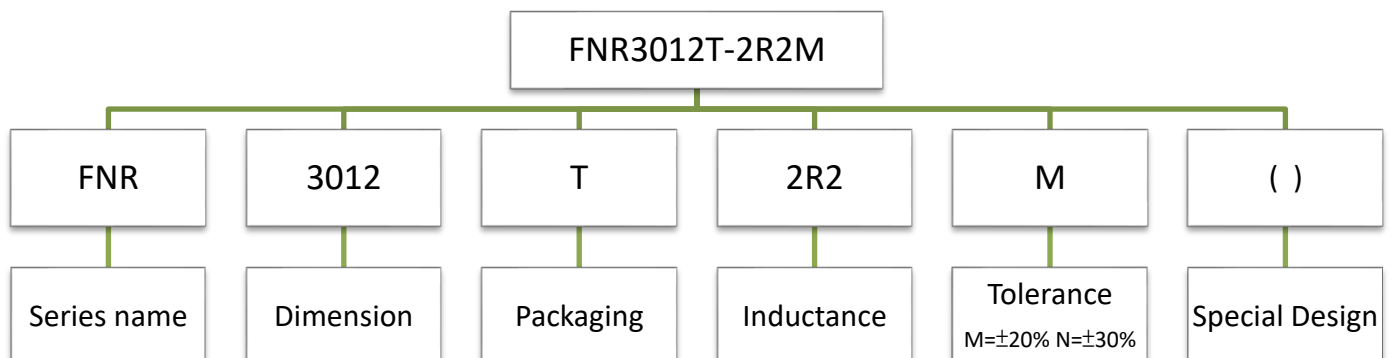

## ELECTRICAL CHARACTERISTICS

Part No.	Inductance (uH)	Inductance tolerance	Test Frequency (kHz)	DC Resistance (Ω)±20%	Saturation current Isat(mA)		Temperature rise current Irms(mA)	
					Typ.	Max.	Typ.	Max.
FNR3012T-1R0N	1.0	±30%	100	0.056	2200	1500	1700	1490
FNR3012T-1R5N	1.5	±30%	100	0.060	1700	1360	1690	1400
FNR3012T-2R2M	2.2	±20%	100	0.080	1500	1100	1350	1200
FNR3012T-3R3M	3.3	±20%	100	0.100	1200	910	1190	1050
FNR3012T-4R7M	4.7	±20%	100	0.160	1000	890	1000	980
FNR3012T-6R8M	6.8	±20%	100	0.235	850	700	840	740
FNR3012T-100M	10	±20%	100	0.290	730	650	720	630
FNR3012T-150M	15	±20%	100	0.450	610	500	610	510
FNR3012T-220M	22	±20%	100	0.630	550	450	550	440
FNR3012T-330M	33	±20%	100	1.030	460	310	460	300
FNR3012T-470M	47	±20%	100	1.450	350	270	350	260

\*The saturation current value (Isat) is the DC current value having inductance decrease down to 30% (at 25°C)

\*The temperature rise current value ( Irms )is the DC current value having temperature increase up to 40°C (at 25°C)

\*Rated current: smaller value of either Isat or Irms.

## RECOMMENDED SOLDERING CONDITIONS

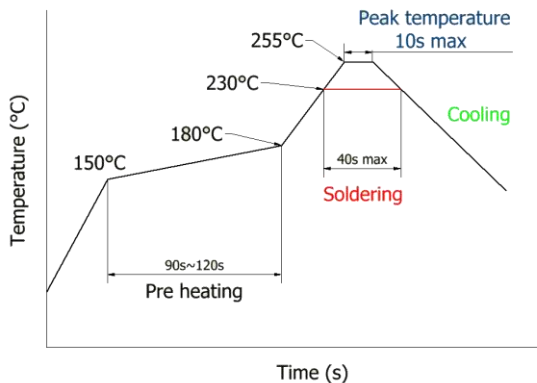

## PACKAGE

### (1) Taping specifications

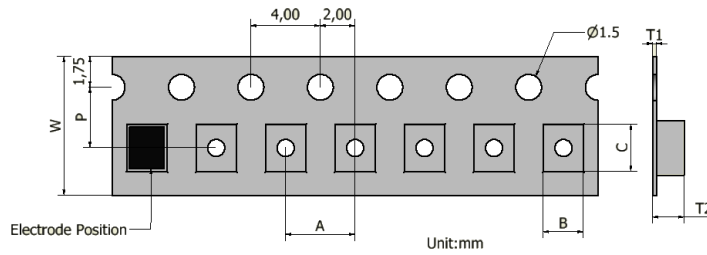

Type	W	P	A	B	C	T1	T2
FNR3012	8	3.5	4.0	3.2	3.2	0.3	1.6

### (2) Reel Specifications

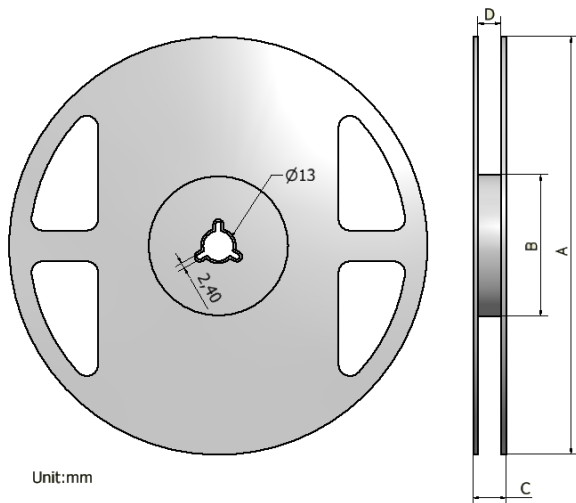

Unit:mm

Type	A	B	C	D	Q'ty/Reel
FNR3012	180±0.1	60±0.1	14.5±0.1	10±0.15	2000

### Label

Wire Wound Power Inductors  
 FNR3012T-□□□M/N  
 2,000PCS  
 Lot No. \_\_\_\_\_  
 FUMIWA TECHNIAL CO., LTD.

Type	Q'ty
PCS/Reel	2000
Reel/inner Box	10000
Inner Box/Carton	50000