

FNR4010series

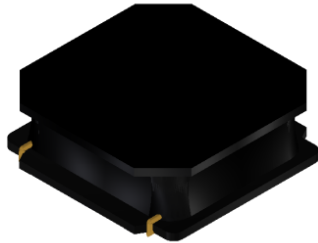

CONSTRUCTION

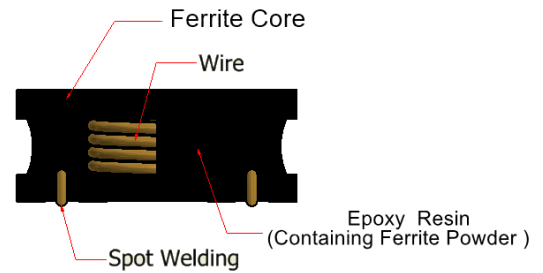

FEATURES

Magnetically structure
Low DC resistance
Large Current Capability

APPLICATIONS

Hard Disk Drives
Car audio equipment
Tablet PC
Navigation system
SSD
Touch Panel

SPECIFICATIONS

Operating temperature range	-40 to +125°C
Storage temperature range	Under 25°C
Packaging style	Taping
Quantities	2,000 pieces/reel

SHAPE AND DIMENSIONS

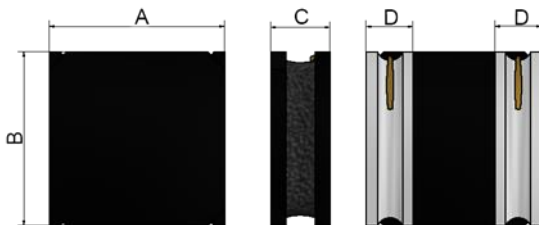

RECOMMENDED PATTERN

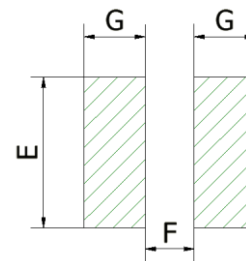

(Unit: mm)

TYPE	A	B	C	D	E	F	G
FNR4010	4.0±0.2	4.0±0.2	1.02max	1.3±0.3	4.2	1.2	1.5

PRODUCT IDENTIFICATION (ex.)

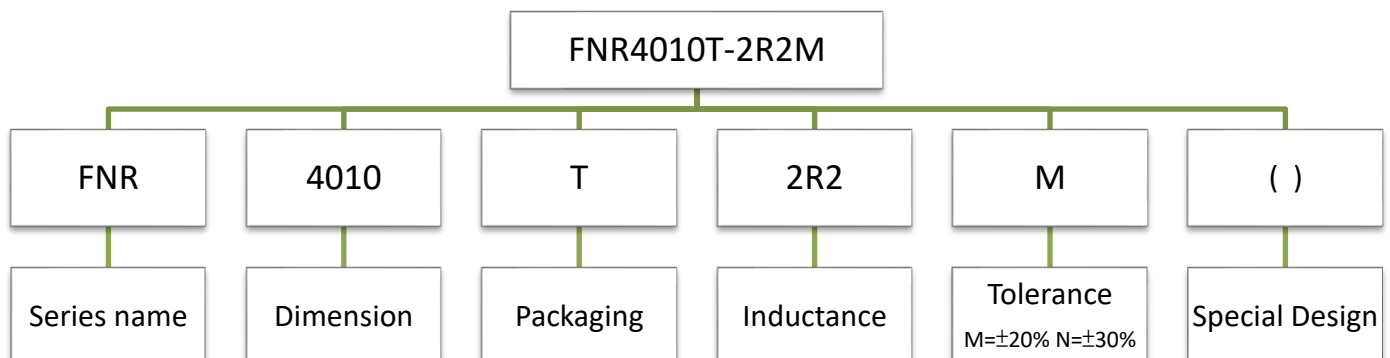

ELECTRICAL CHARACTERISTICS

Part No.	Inductance (uH)	Inductance tolerance	Test Frequency (kHz)	DC Resistance (Ω) $\pm 20\%$	Saturation current Isat(mA)		Temperature rise current Irms(mA)	
					Typ.	Max.	Typ.	Max.
FNR4010T-1R0N	1.0	$\pm 30\%$	100	0.069	2500	2300	2200	2000
FNR4010T-2R2M	2.2	$\pm 20\%$	100	0.119	1600	1400	1400	1200
FNR4010T-3R3M	3.3	$\pm 20\%$	100	0.133	1500	1300	1300	1100
FNR4010T-4R7M	4.7	$\pm 20\%$	100	0.200	1300	1100	1200	950
FNR4010T-6R8M	6.8	$\pm 20\%$	100	0.300	1000	900	1000	800
FNR4010T-8R2M	8.2	$\pm 20\%$	100	0.330	900	700	900	750
FNR4010T-100M	10	$\pm 20\%$	100	0.400	800	620	800	700
FNR4010T-150M	15	$\pm 20\%$	100	0.510	700	550	700	600
FNR4010T-220M	22	$\pm 20\%$	100	1.081	550	350	500	400
FNR4010T-470M	47	$\pm 20\%$	100	1.808	250	200	300	250

*The saturation current value (Isat) is the DC current value having inductance decrease down to 30% (at 25°C)

*The temperature rise current value (Irms) is the DC current value having temperature increase up to 40°C (at 25°C)

*Rated current: smaller value of either Isat or Irms.

RECOMMENDED SOLDERING CONDITIONS

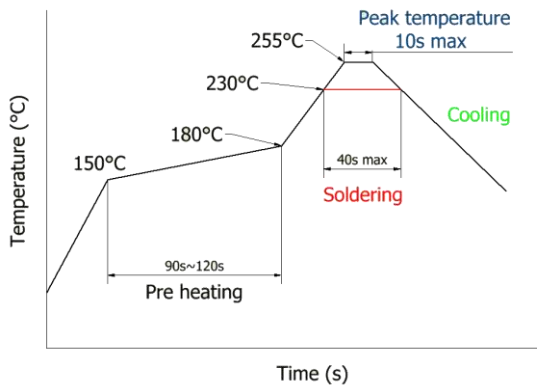

PACKAGE

(1) Taping specifications

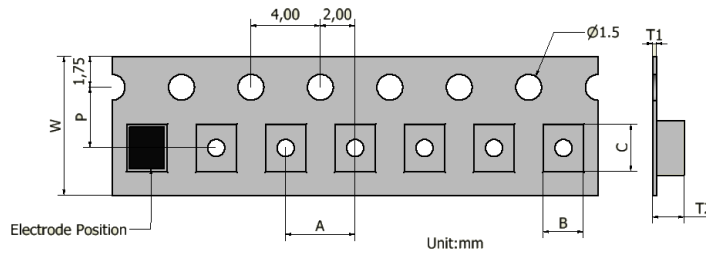

Type	W	P	A	B	C	T1	T2
FNR4010	12±0.3	5.5	8.0±0.1	4.2±0.1	4.2±0.1	0.4±0.05	1.4±0.1

(2) Reel Specifications

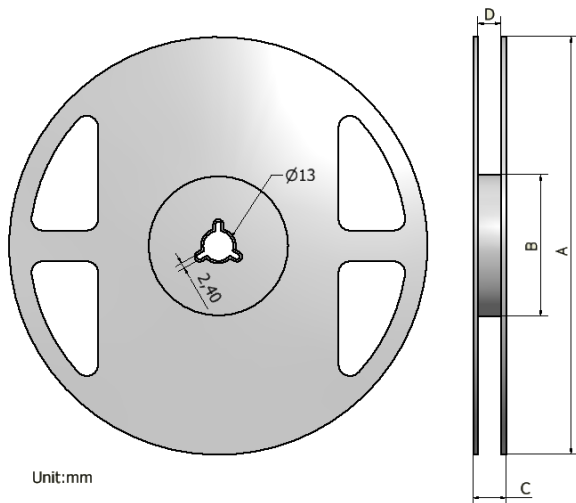

Unit:mm

Type	A	B	C	D	Q'ty/Reel
FNR4010	180±0.1	60±0.1	14.5±0.1	10±0.15	2000

Label

Wire Wound Power Inductors
 FNR4010T-□□□M/N
 2,000PCS
 Lot No. _____
 FUMIWA TECHNIAL CO., LTD.

Type	Q'ty
PCS/Reel	2000
Reel/inner Box	10000
Inner Box/Carton	50000