

FNR5020-Zseries

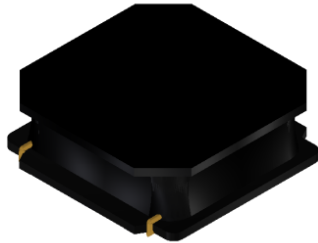

CONSTRUCTION

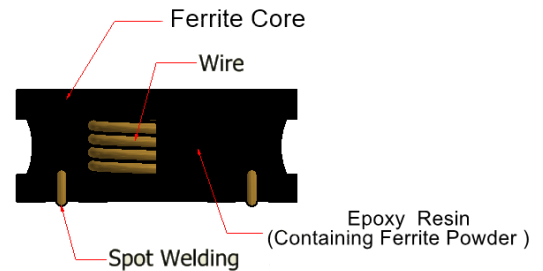

FEATURES

Magnetically structure
Low DC resistance
Large Current Capability

APPLICATIONS

Hard Disk Drives
Car audio equipment
Tablet PC
Navigation system
SSD
Touch Panel

SPECIFICATIONS

Operating temperature range	-25 to +125°C
Storage temperature range	Under 25°C
Packaging style	Taping
Quantities	2,000 pieces/reel

SHAPE AND DIMENSIONS

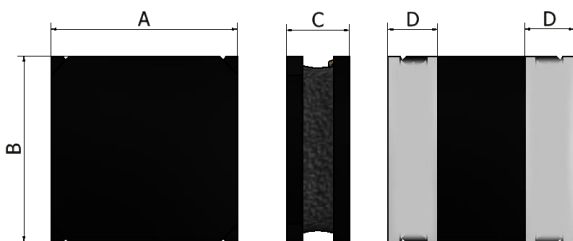

RECOMMENDED PATTERN

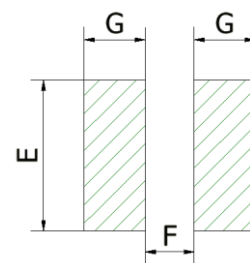

(Unit: mm)

TYPE	A	B	C	D	E	F	G
FNR5020-Z	5.0±0.2	5.0±0.2	2.10 max.	1.7±0.3	4.2	1.4.	1.8

PRODUCT IDENTIFICATION (ex.)

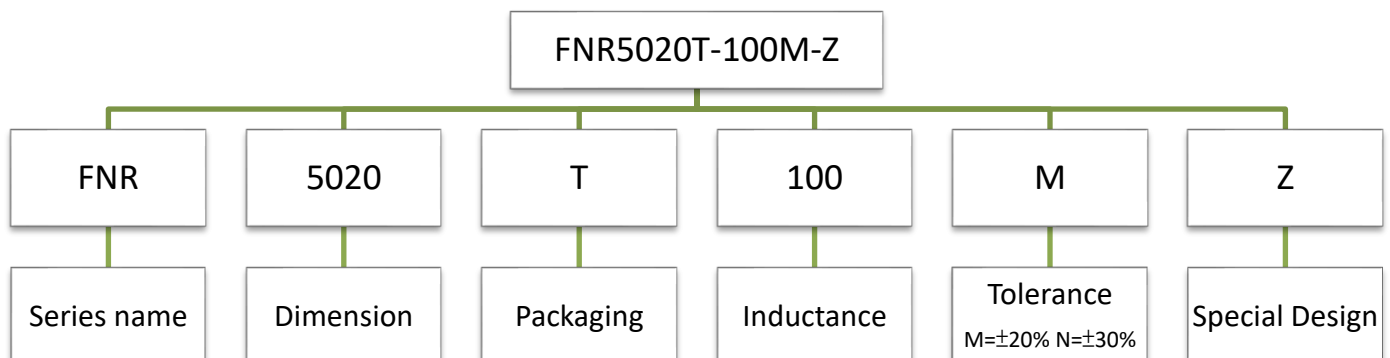

ELECTRICAL CHARACTERISTICS

Part No.	Inductance (uH)	Inductance tolerance	Test Frequency (kHz)	DC Resistance (Ω) ±30%	Saturation current Isat(mA)	Temperature rise current Irms(mA)
					Max.	Max.
FNR5020T-1R0N-Z	1.0	±30%	100	0.020	4100	3800
FNR5020T-1R2N-Z	1.2	±30%	100	0.025	4100	3600
FNR5020T-1R5N-Z	1.5	±30%	100	0.030	4100	3200
FNR5020T-2R2N-Z	2.2	±30%	100	0.040	3200	2700
FNR5020T-3R3N-Z	3.3	±30%	100	0.050	2550	2300
FNR5020T-4R7M-Z	4.7	±20%	100	0.057	2500	2200
FNR5020T-6R8M-Z	6.8	±20%	100	0.083	2050	1800
FNR5020T-8R2M-Z	8.2	±20%	100	0.098	1850	1650
FNR5020T-100M-Z	10	±20%	100	0.120	1700	1550
FNR5020T-120M-Z	12	±20%	100	0.140	1500	1400
FNR5020T-150M-Z	15	±20%	100	0.165	1350	1250
FNR5020T-180M-Z	18	±20%	100	0.200	1250	1150
FNR5020T-220M-Z	22	±20%	100	0.250	1150	1100
FNR5020T-330M-Z	33	±20%	100	0.400	920	900
FNR5020T-470M-Z	47	±20%	100	0.580	770	750
FNR5020T-680M-Z	68	±20%	100	0.740	650	640
FNR5020T-820M-Z	82	±20%	100	0.965	650	500
FNR5020T-101M-Z	100	±20%	100	1.100	530	400

*The saturation current value (Isat) is the DC current value having inductance decrease down to 30% (at 25°C)

*The temperature rise current value (Irms)is the DC current value having temperature increase up to 40°C (at 25°C)

*Rated current: smaller value of either Isat or Irms.

RECOMMENDED SOLDERING CONDITIONS

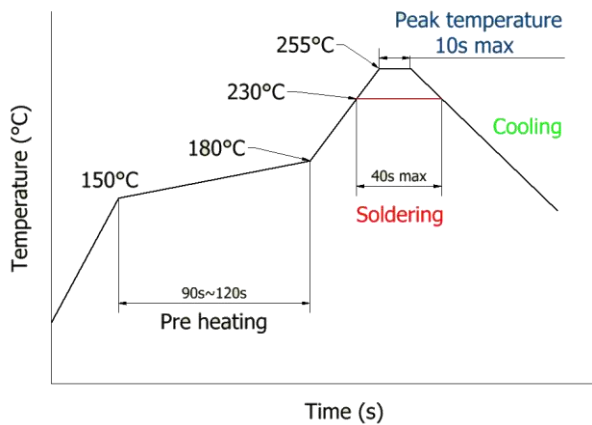

PACKAGE

(1) Taping specifications

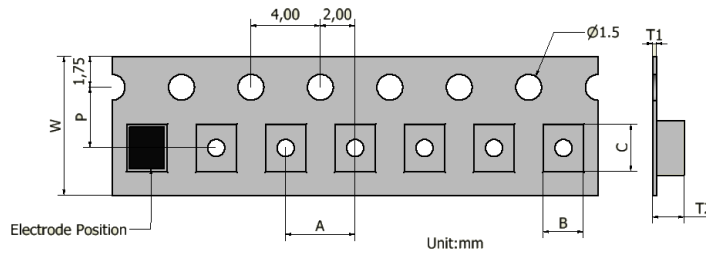

Type	W	P	A	B	C	T1	T2
FNR5020-Z	12	5.5	8.0	5.4	5.4	0.30	2.5

(2) Reel Specifications

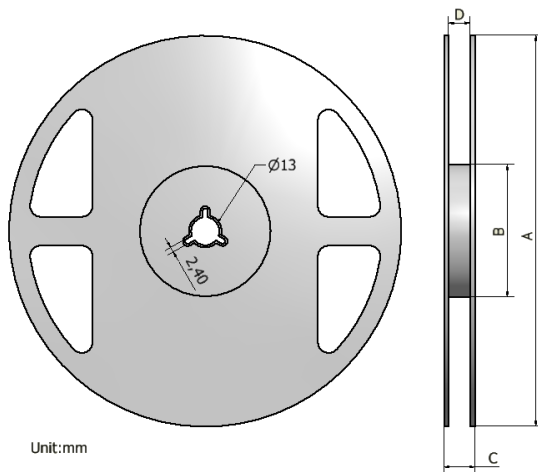

Type	A	B	C	D	Q'ty/Reel
FNR5020-Z	330±1.5	75±2.0	17.5±0.5	12.5±0.5	2000

Label

Wire Wound Power Inductors
 FNR5020T-□□□M/N-Z
 2,000PCS
 Lot No. _____
 FUMIWA TECHNIAL CO., LTD.

Type	Q'ty
PCS/Reel	2000
Reel/inner Box	10000
Inner Box/Carton	50000