

FNR5040-Zseries

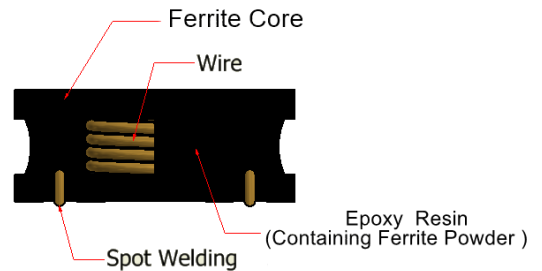

CONSTRUCTION



FEATURES

Magnetically structure
Low DC resistance
Large Current Capability

APPLICATIONS

Hard Disk Drives
Car audio equipment
Tablet PC
Navigation system
SSD
Touch Panel

SPECIFICATIONS

Operating temperature range	-40 to +125°C
Storage temperature range	Under 25°C
Packaging style	Taping
Quantities	1,500 pieces/reel

SHAPE AND DIMENSIONS

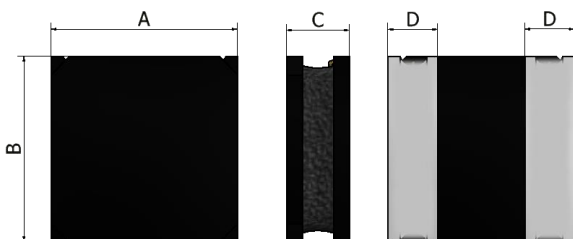

RECOMMENDED PATTERN

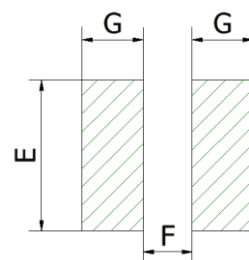

(Unit: mm)

TYPE	A	B	C	D	E	F	G
FNR5040-Z	5.0±0.2	5.0±0.2	4.0 max.	1.7±0.3	4.2	1.4.	1.8

PRODUCT IDENTIFICATION (ex.)

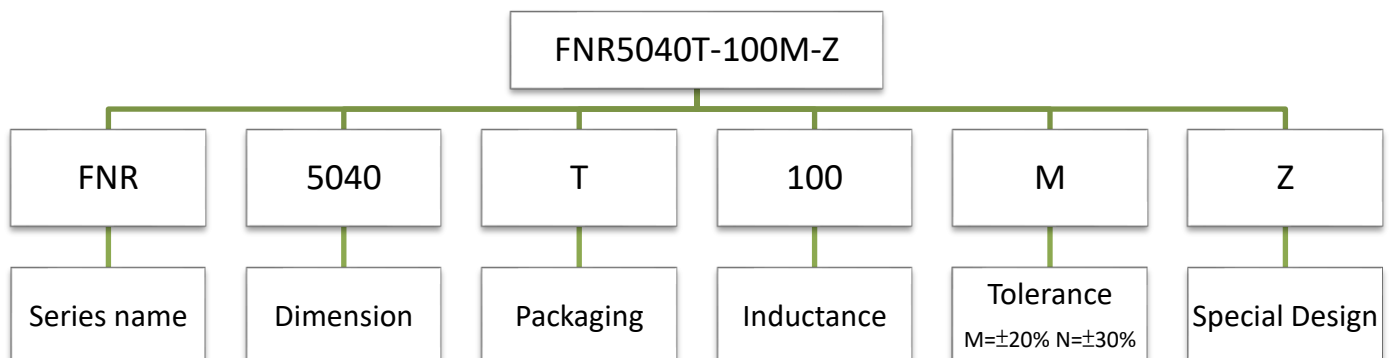

ELECTRICAL CHARACTERISTICS

Part No.	Inductance (uH)	Inductance tolerance	Test Frequency (kHz)	DC Resistance (Ω) ±30%	Saturation current Isat(mA)	Temperature rise current Irms(mA)
					Max.	Max.
FNR5040T-1R0N-Z	1.0	±30%	100	0.012	7350	4900
FNR5040T-1R2N-Z	1.2	±30%	100	0.016	6500	4150
FNR5040T-1R5N-Z	1.5	±30%	100	0.018	6300	4000
FNR5040T-2R2N-Z	2.2	±30%	100	0.019	4900	3800
FNR5040T-3R3M-Z	3.3	±20%	100	0.024	3950	3400
FNR5040T-4R7M-Z	4.7	±20%	100	0.032	3500	3000
FNR5040T-6R8M-Z	6.8	±20%	100	0.043	2900	2500
FNR5040T-100M-Z	10	±20%	100	0.064	2350	2100
FNR5040T-150M-Z	15	±20%	100	0.086	2000	2000
FNR5040T-220M-Z	22	±20%	100	0.129	1600	1500
FNR5040T-330M-Z	33	±20%	100	0.188	1300	1200
FNR5040T-470M-Z	47	±20%	100	0.272	1100	1000
FNR5040T-680M-Z	68	±20%	100	0.400	900	800
FNR5040T-101M-Z	100	±20%	100	0.560	750	700
FNR5040T-151M-Z	150	±20%	100	0.750	650	600
FNR5040T-221M-Z	220	±20%	100	1.280	480	400
FNR5040T-331M-Z	330	±20%	100	2.100	420	360
FNR5040T-471M-Z	470	±20%	100	3.000	370	350
FNR5040T-102M-Z	1000	±20%	100	6.200	250	250
FNR5040T-222M-Z	2200	±20%	100	13.00	100	100

*The saturation current value (Isat) is the DC current value having inductance decrease down to 30% (at 25°C)

*The temperature rise current value (Irms)is the DC current value having temperature increase up to 40°C (at 25°C)

*Rated current: smaller value of either Isat or Irms.

RECOMMENDED SOLDERING CONDITIONS

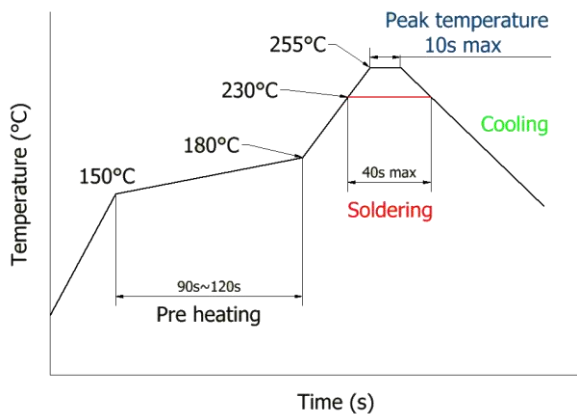

PACKAGE

(1) Taping specifications

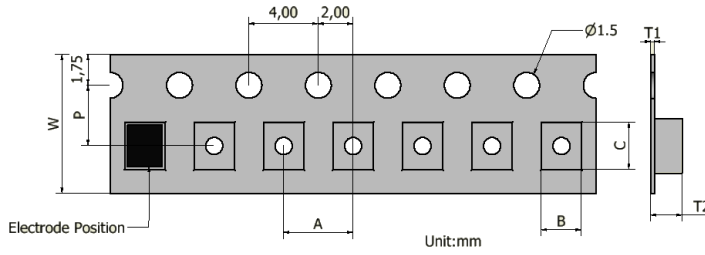

Type	W	P	A	B	C	T1	T2
FNR5040-Z	12	5.5	8.0	5.4	5.4	0.30	4.5

(2) Reel Specifications

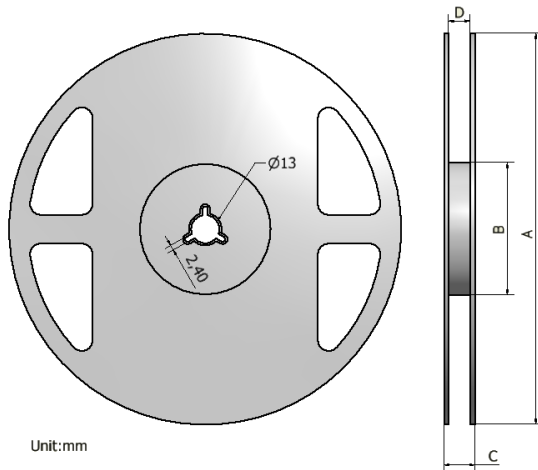

Unit:mm

Type	A	B	C	D	Q'ty/Reel
FNR5040-Z	330±1.5	75±2.0	17.5±0.5	12.5±0.5	1500

Label

Wire Wound Power Inductors
 FNR5040T-□□□M/N-Z
 1,500PCS
 Lot No. _____
 FUMIWA TECHNIAL CO., LTD.

Type	Q'ty
PCS/Reel	1500
Reel/inner Box	7500
Inner Box/Carton	37500