

FNR6020series

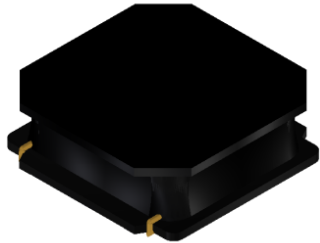

CONSTRUCTION

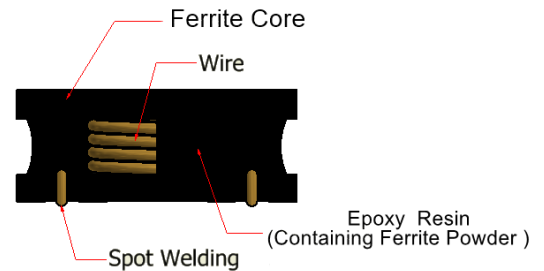

FEATURES

Magnetically structure
Low DC resistance
Large Current Capability

APPLICATIONS

Hard Disk Drives
Car audio equipment
Tablet PC
Navigation system
SSD
Touch Panel

SPECIFICATIONS

Operating temperature range	-40 to +125°C
Storage temperature range	Under 25°C
Packaging style	Taping
Quantities	2,000 pieces/reel

SHAPE AND DIMENSIONS

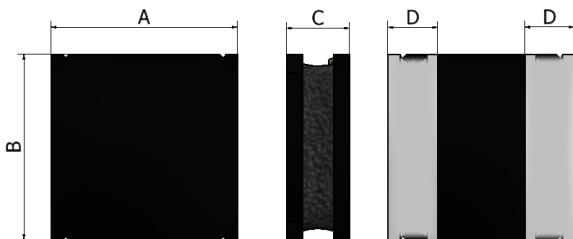

RECOMMENDED PATTERN

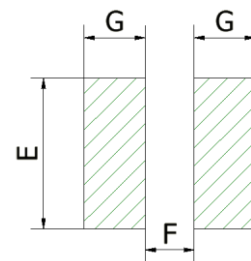

(Unit: mm)

TYPE	A	B	C	D	E	F	G
FNR6020	6.0±0.1	6.0±0.1	2.0±0.2	1.4±0.2	6.2	2.8	1.8

PRODUCT IDENTIFICATION (ex.)

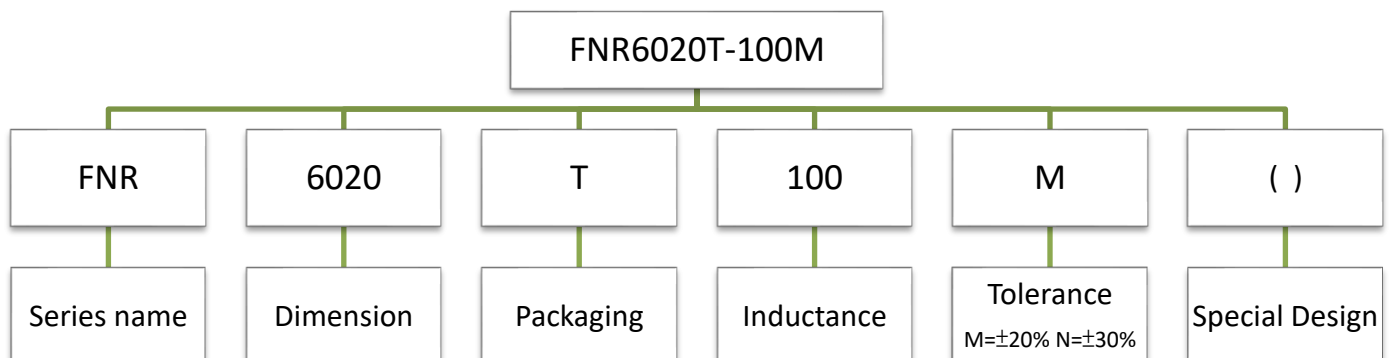

ELECTRICAL CHARACTERISTICS

Part No.	Inductance (uH)	Inductance tolerance	Test Frequency (kHz)	DC Resistance (Ω) \pm 30%	Saturation current Isat(mA)		Temperature rise current Irms(mA)	
					Typ.	Max.	Typ.	Max.
FNR6020T-R90N	0.9	\pm 30	100	0.018	6300	5000	4200	4000
FNR6020T-1R0N	1.0	\pm 30	100	0.019	6200	4900	4100	3900
FNR6020T-1R5N	1.5	\pm 30	100	0.026	5000	4000	3600	3200
FNR6020T-2R2N	2.2	\pm 30	100	0.034	4200	3500	3200	2900
FNR6020T-3R3N	3.3	\pm 30	100	0.040	3200	3000	2700	2400
FNR6020T-4R7N	4.7	\pm 30	100	0.058	2500	2300	2200	2000
FNR6020T-6R8M	6.8	\pm 20	100	0.085	2200	2000	1800	1650
FNR6020T-100M	10	\pm 20	100	0.125	2000	1800	1600	1450
FNR6020T-150M	15	\pm 20	100	0.190	1300	1100	1300	1100
FNR6020T-220M	22	\pm 20	100	0.260	1100	900	1100	900

*The saturation current value (Isat) is the DC current value having inductance decrease down to 30% (at 25°C)

*The temperature rise current value (Irms)is the DC current value having temperature increase up to 40°C (at 25°C)

*Rated current: smaller value of either Isat or Irms.

RECOMMENDED SOLDERING CONDITIONS

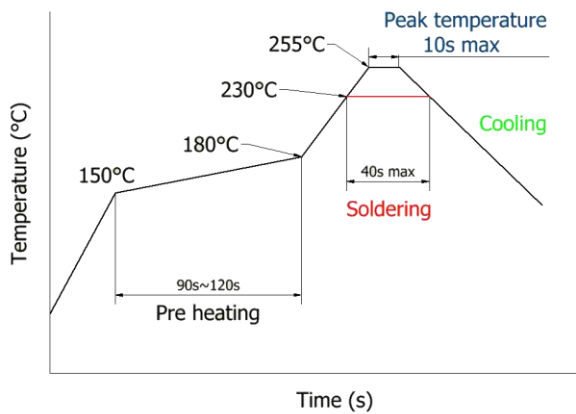

PACKAGE

(1) Taping specifications

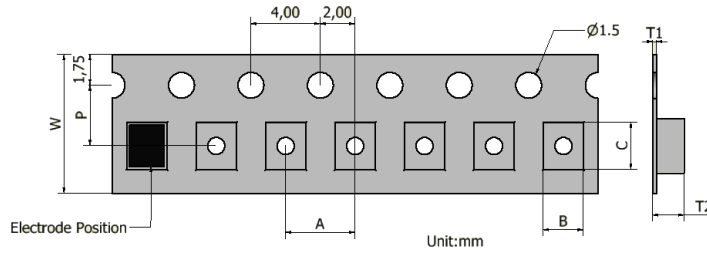

Type	W	P	A	B	C	T1	T2
FNR6020	16	7.5	12.0	7.0	7.0	0.35	2.4

(2) Reel Specifications

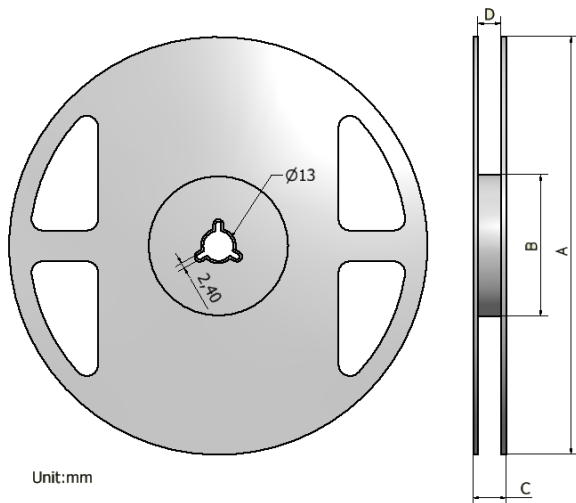

Unit:mm

Type	A	B	C	D	Q'ty/Reel
FNR6020	330±1.5	75±2.0	17.5±0.5	12.5±0.5	2000

Label

Wire Wound Power Inductors
 FNR6020T-□□□M/N
 2,000PCS
 Lot No. _____
 FUMIWA TECHNIAL CO., LTD.

Type	Q'ty
PCS/Reel	2000
Reel/inner Box	10000
Inner Box/Carton	50000