

FNR252012series

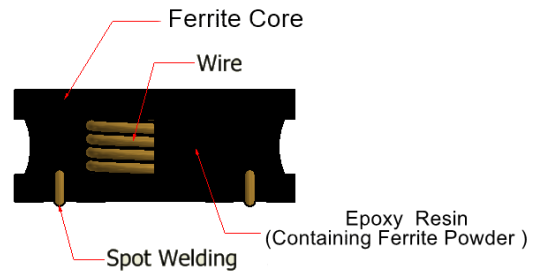

CONSTRUCTION



FEATURES

Magnetically structure
Low DC resistance
Large Current Capability

APPLICATIONS

Hard Disk Drives
Car audio equipment
Tablet PC
Navigation system
SSD
Touch Panel

SPECIFICATIONS

Operating temperature range	-40 to +125°C
Storage temperature range	Under 25°C
Packaging style	Taping
Quantities	2,000 pieces/reel

SHAPE AND DIMENSIONS

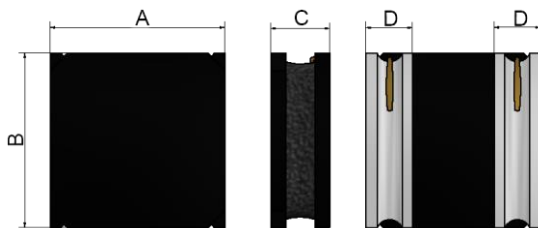

RECOMMENDED PATTERN

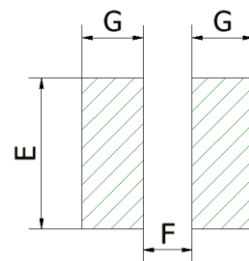

(Unit: mm)

TYPE	A	B	C	D	E	F	G
FNR252012	2.5±0.2	2.0±0.2	1.2max	0.8±0.2	2.4	0.9	0.9

PRODUCT IDENTIFICATION (ex.)

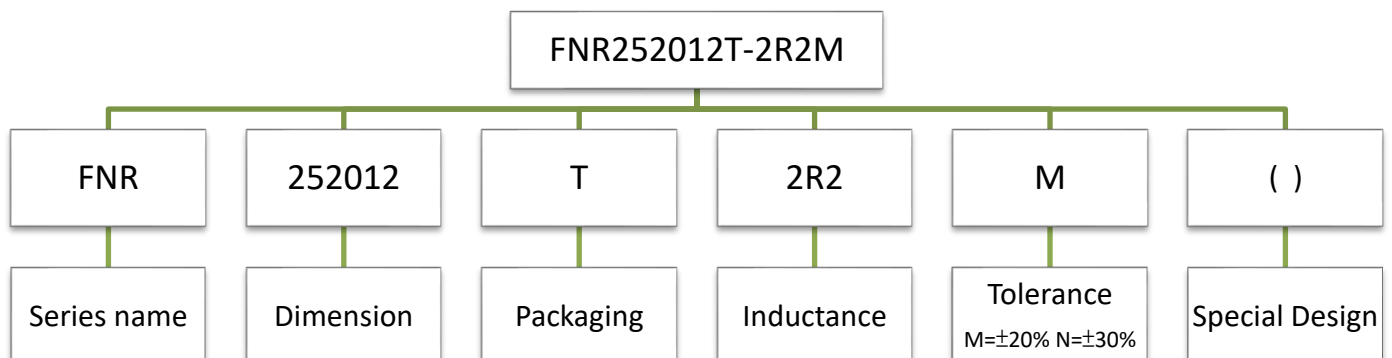

ELECTRICAL CHARACTERISTICS

Part No.	Inductance (uH)	Inductance tolerance	Test Frequency (MHz)	DC Resistance (Ω) $\pm 20\%$	Saturation current Isat(mA)		Temperature rise current Irms(mA)	
					Typ.	Max.	Typ.	Max.
FNR252012T-R33N	0.33	$\pm 30\%$	1	0.027	4400	4200	4000	3400
FNR252012T-R47N	0.47	$\pm 30\%$	1	0.038	4100	3900	3800	2800
FNR252012T-1R0N	1.0	$\pm 30\%$	1	0.061	2900	2700	2500	2200
FNR252012T-1R5N	1.5	$\pm 30\%$	1	0.081	2450	2200	2400	2100
FNR252012T-2R2M	2.2	$\pm 20\%$	1	0.110	2000	1800	2100	1700
FNR252012T-3R3M	3.3	$\pm 20\%$	1	0.152	1750	1600	1900	1600
FNR252012T-4R7M	4.7	$\pm 20\%$	1	0.221	1500	1300	1500	1300
FNR252012T-6R8M	6.8	$\pm 20\%$	1	0.358	1050	1000	1050	1000
FNR252012T-100M	10	$\pm 20\%$	1	0.437	950	900	950	900

*The saturation current value (Isat) is the DC current value having inductance decrease down to 30% (at 25°C)

*The temperature rise current value (Irms) is the DC current value having temperature increase up to 40°C (at 25°C)

*Rated current: smaller value of either Isat or Irms.

RECOMMENDED SOLDERING CONDITIONS

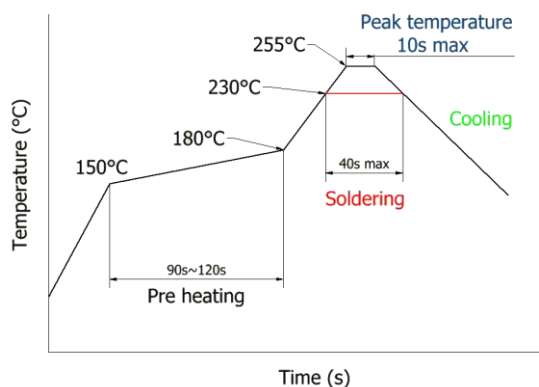

PACKAGE

(1) Taping specifications

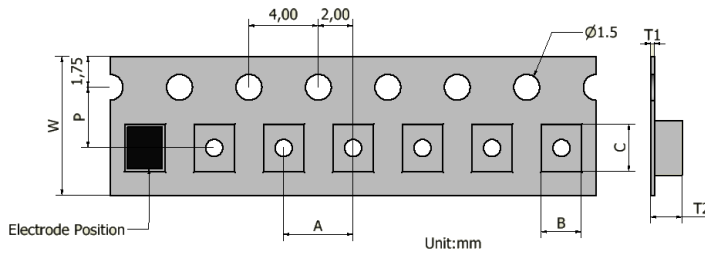

Type	W	P	A	B	C	T1	T2
FNR252012	8	3.5	4.0	2.3	2.7	0.23	1.4

(2) Reel Specifications

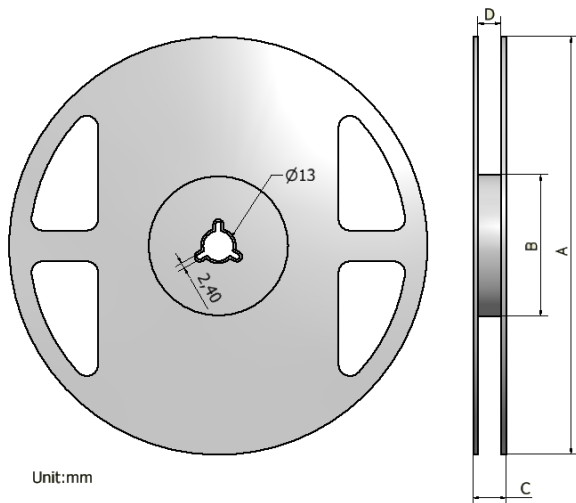

Unit:mm

Type	A	B	C	D	Q'ty/Reel
FNR252012	180±0.1	60±0.1	14.5±0.1	10±0.15	2000

Label

Wire Wound Power Inductors
 FNR252012T-□□□M/N
 2,000PCS
 Lot No. _____
 FUMIWA TECHNIAL CO., LTD.

Type	Q'ty
PCS/Reel	2000
Reel/inner Box	10000
Inner Box/Carton	50000