

FAT4532T-181-G5P

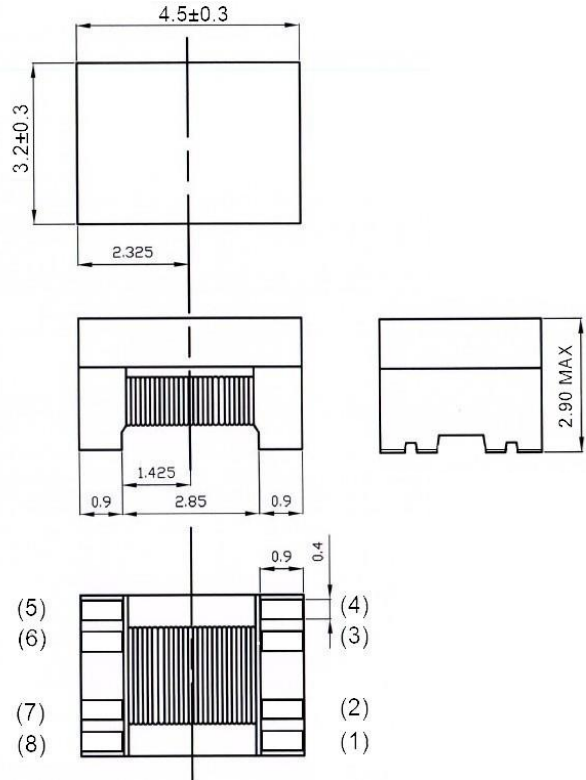

SHAPE AND DIMENSIONS (mm)



RECOMMEND LAND PATTERN

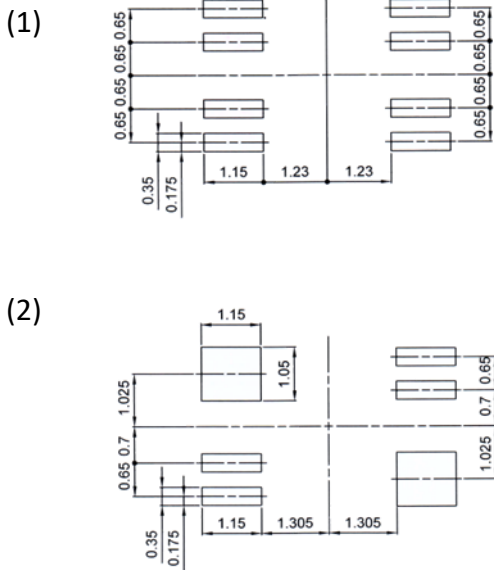

FEATURES

- Fully automated production lines
- Compatible with 1000BASE-T/2.5GBASE-T/5GBASE-T PoE+(600mA)
- IEEE 802.3 Ethernet compatible
- RoHS compliant

APPLICATIONS

- Servers, Switches, Routers, IP cameras
- Network devices and communication equipment
- Industrial computers
- Digital consumer electronics

SCHEMATIC DIAGRAM

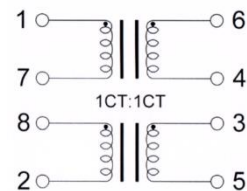

RATING

- Operating temperature range: -40 to 85°C
- Storage temperature range: 20 to 25°C
- R.H. 65% (For Reference)

PRODUCT IDENTIFICATION (ex.)

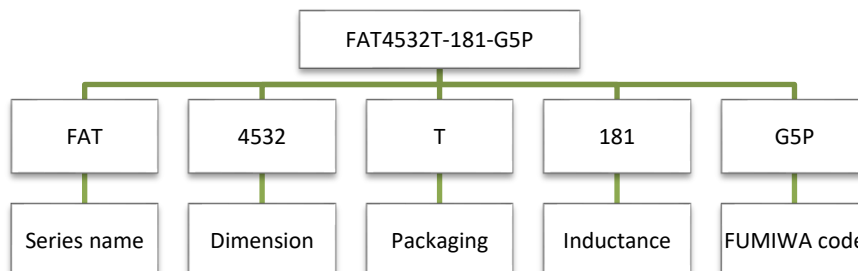

ELECTRICAL CHARACTERISTICS

Part No.	Inductance [DC bias 8mA, 100KHz] Pin(1)(2) · short(7)(8) Pin(5)(6) · short(3)(4) (μH)Min.	Insertion loss [1 to 100MHz] (dB)Max.	Insertion loss [100 to 200MHz] (dB)Max.	Inter-winding capacitance [100KHz] (pF)Max.	Turn ratio	Rated current (mA)Max.
FAT4532T-181-G5P	180	0.9	1.4	35	1CT:1CT	600

RECOMMENDED SOLDERING CONDITIONS

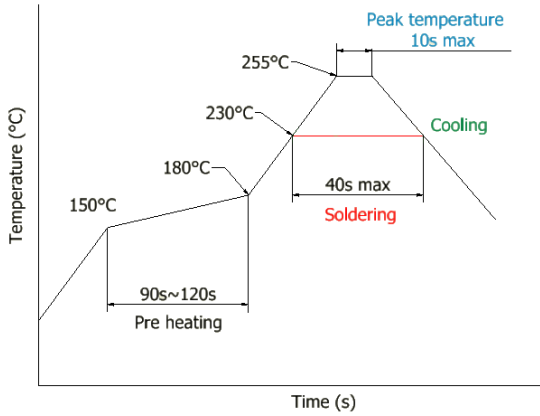

PACKAGE

(1) Taping specifications

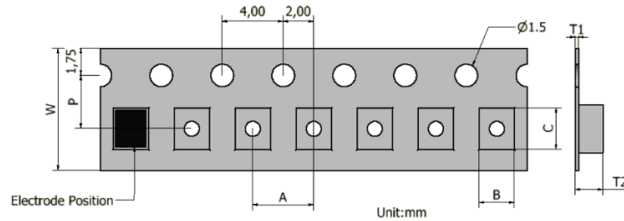

Type	W	P	A	B	C	T1	T2
FAT4532	12±0.2	5.5±0.05	8.0±0.1	3.45±0.1	4.9±0.1	0.20±0.05	3.20±0.1

(2) Reel specifications

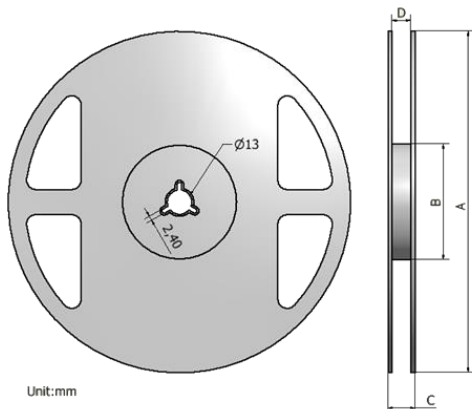

Label

Pulse Transformers
 FAT4532T-181-G5P
 2,000 PCS
 Lot No. _____
 FUMIWA TECHNICAL CO., LTD.

Type	A	B	C	D	Q'ty/Reel
FAT4532	330±1.5	75±2.0	18±0.5	13±0.5	2,000

Note:

1. Please make sure that your product is has been evaluated and confirmed against your specifications when our product is mounted to your product.
2. Do not knock nor drop.
3. All the items and parameters in this product specification have been prescribed on the premise that our product is used for the purpose, under the condition and in the environment agreed upon between you and us. You are requested not to use our product deviating from such agreement.
4. Please keep the distance between transformer/coil and other components (refer to the standard IEC 950)